

BFS-11

Installation Guide

Please scan the QR code to view and download the installation manual



SAVE THESE INSTRUCTIONS –This manual contains important instructions for ZJBENY Rapid Shutdown System Equipment that shall be followed during installation and maintenance of the Rapid Shutdown System Equipment, BFS-11, BFS-ESW11, BFS-ESW12, BFS-ESW21, BFS-ESW21-K, BFS-ESW11-K BFS-ESW12-K.

DISCLAIMER

No part of this publication may be stored, reproduced or copied without prior written permission from ZJBENY The material furnished in this document is believed to be accurate and reliable however, ZJBENY assumes no responsibility for the use of this material. ZJBENY reserves the right to make changes to the information contained at any time without prior notice. All products and company names mentioned in this manual are trademarks or registered trademarks of their respective holders. The information contained herein is subject to change without prior notice for improvement.

SAFETY SYMBOLS

Please contact the below concerning technical questions about this product:-



Warning - Failure to heed this the information indicated by this symbol may lead to dangerous conditions, possibly resulting in death or serious bodily injury.



Caution - Failure to heed this the information indicated by this symbol may lead to dangerous conditions, possibly resulting in minor or light bodily injuries and/or substantial property damage.



Information - Denotes important information about safety issues.



Note - Denotes additional information.

SAFETY INSTRUCTIONS



Warning - The rapid shutdown device(BFS) must be installed in a well-ventilated environment: The BFS should be 8-30cm away from the roof and not stick close to the PV panel, so as to meet the ambient temperature required by the specification (less than 55°C), there is a risk of product damage if the temperature is higher than 55°C. We are not responsible for the warranty if any damage by using in a poor installation environment.



Please do not connect the PV modules in parallel to the inverter input. If there are multiple PV strings per MPPT on the inverter, all Rapid Shutdown Devices(BFS) from the same MPPT must be connected to the same emergency button switch.



The BFS is an electrical product and should only be installed by a suitably qualified person, in accordance with local regulations such as BS7671 (UK) and ANSI/NFPA70 (USA).



When modifying and existing installation, isolate the inverter from the PV array by turning OFF the DC isolator / switch disconnect or turn OFF the inverter and the AC switch.



PV Panel input and output connectors are not environmentally sealed until they are mated. Disconnected connectors should be plugged into an appropriate mating part or used with suitable watertight caps.



BFS DC input and output connectors are not environmentally sealed until they are mated. Disconnected connectors should be plugged into an appropriate mating part or used with suitable watertight caps.



The ZJBENY BFS is fitted with Multi Contact MC4 (KBT4/KST4) connectors and to maintain UL connector approval listings these should only be mated with their counterpart connector. PV connectors should not be connected or disconnected under load.



Incorrect connections to the BFS may cause failure.

CAUTIONS



Installation of the ZJBENY BFS without ensuring compatibility of the module\inverter connectors with the BFS connectors may be unsafe and cause operational problems. For mechanical compatibility of the modules\inverter and the BFS, use identical connectors from the same manufacturer on both the BFS and modules, or obtain verification that the connectors to be used are compatible.

Installation Guide



If the ZJBENY BFS is to be mounted directly to the PV frame or module, obtain guidance from the module manufacturer regarding it's location and also verify the impact on the module warranty.

INTRODUCTION

The ZJBENY BFS product is Rapid Shut Down Equipment for connection to PV panel arrays in order to achieve compliance to 2014 NEC 690.12 and 2017 NEC 690.12.

The BFS automatically shuts down array output to the PV inverter when it detects a temperature in excess to 85°C (BFS-11) : this function was not evaluated by UL).

The BFS can be installed without any set-up and with any string inverter as its functionality is completely independent. "Plug & Play" style installation using industry standard connectors makes the ZJBENY BFS for new installations as well as retro-fit; and its mains powered independent DC power supply and emergency switch unit allows flexibility for positioning for user convenience giving Manual Emergency Shutdown, as well responding to local or area grid shutdown.

PARTS

BFS-11	BFS Rapid Shutdown System Unit
BFS-ESW11	Emergency Rapid Shutdown Switch Unit (for BFS-11)-includes 24 VDC power supply
BFS-ESW12	Emergency Rapid Shutdown Switch Unit (for BFS-11)-includes 24 VDC power supply
BFS-ESW21	Emergency Button Switch for BFS-11, (200V-480V AC power input).
BFS-ESW11-K	Emergency Rapid Shutdown Switch Unit with Key Lock (standard key) for BFS-11- includes 24 VDC power supply
BFS-ESW12-K	Emergency Rapid Shutdown Switch Unit with Key Lock (standard key) for BFS-11- includes 24 VDC power supply
BFS-ESW21-K	Emergency Button Switch with Key Lock for BFS-11, (200V-480V AC power input).

INSTALLATION & CONNECTION

One BFS will control two solar panels and for compliance with 2017 NEC it should be mounted within the array boundary of the two panels, where the two panels are no greater than 1' (foot) /30cm apart from each other.

Determine the mounting location of the BFS-11 and fix as shown below.

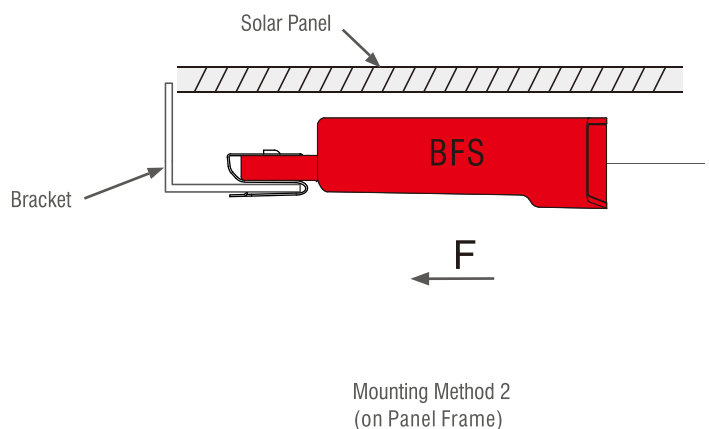
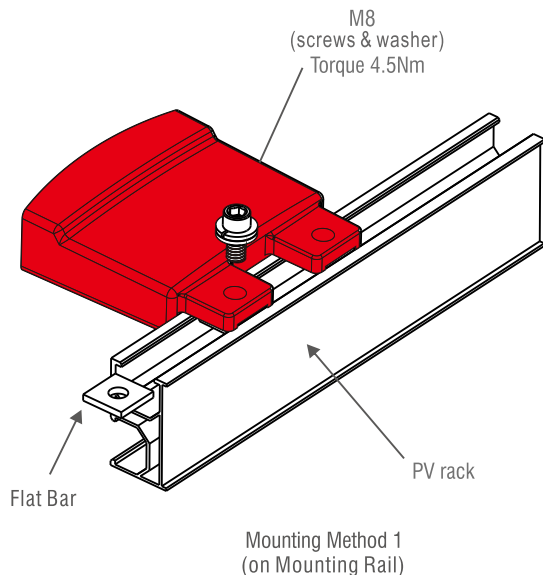

Do not drill through the BFS as this will damage the unit and prevent operation.

Mounting Method 1 offers ease of fixing whilst Mounting Method 2 can be used where more effective use of the BFS's onboard temperature sensing is required, by placing the BFS in position against the underside of the PV panel (or the surface where the temperature needs to be sensed). Once mounted ensure that the BFS is secure.



The BFS is housed in a plastic enclosure therefore grounding of the product is unnecessary

BFS-11 INSTALLATION DIAGRAM

Connect the two PV panels in series (typical wiring example below). Connect the array Positive (+) output connector to the BFS Positive (+) input connector. Connect the array Negative (-) output connector to the BFS Negative (-) input connector.

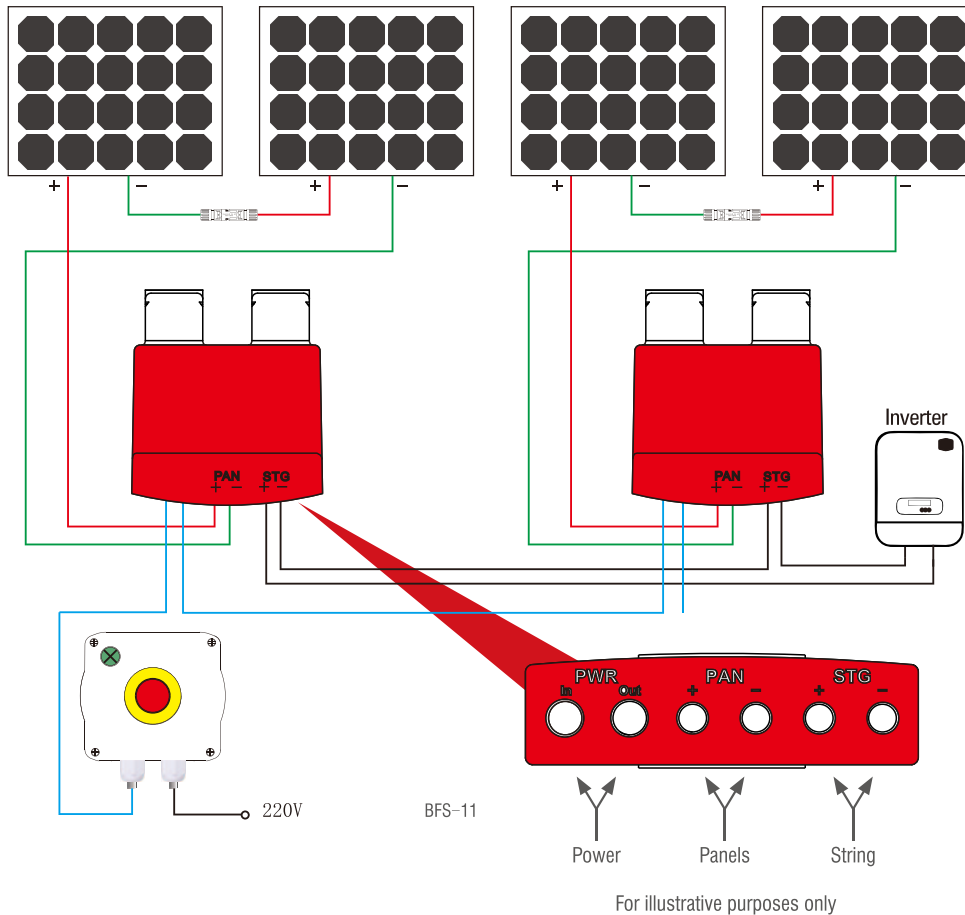

- For NEC 2017/2020 compliance PV panels should be <math><40V</math> for 2-to-1 wiring, and - Warning** - Ensure that you have identified the inputs correctly. The BFS input cables are the shorter ones.
Connect the BFS's two output cables to the DC isolator/Solar Inverter ensuring that the correct polarity is maintained throughout the electrical wiring.
- The BFS is OFF giving no array output until such time as the external DC power supply is energised and the Emergency Switch is in its non-activated position.

EMERGENCY RAPID SHUTDOWN SWITCH INSTALLATION

The Emergency Rapid Shutdown Switch Unit (BFS-ESW11/BFS-ESW12/BFS-ESW21/BFS-ESW21-K/BFS-ESW11-K) hereafter referred to as BFS-ESW11, for installation; can be conveniently located anywhere for emergency access and is supplied with an internal 24VDC power supply to interface with the BFS units.

Locate a convenient position for mounting the BFS-ESW11 unit ensuring that mains power connection is also available. Before mounting ensure that the cable entry/exit gland positions are accessible.

Remove the BFS-ESW11 cover taking care not to damage the switch or power supply contained within the BFS-ESW11 enclosure. Insert cable glands (supplied) into position, ensuring that the sealing washer (where supplied) is between the main gland body and the outer enclosure surface, screw the gland into position and then tighten securing/locking nut.

The max distance allowed from button switch to RSD: 150M.

Installation Guide

n The BFS-ESW11 should be connected in accordance with local wiring regulations (e.g. IET for UK, NEC for USA, CEC for Canada).

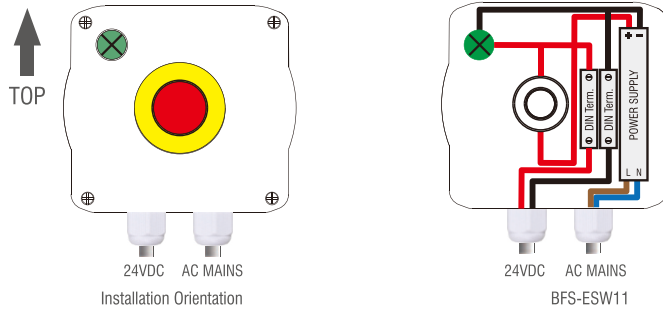

Using appropriate fixings attach the BFS-ESW11 unit vertically to the chosen surface.

! Mounting the BFS-ESW11 non-vertically will invalidate warranty.

Connect the mains supply wire to the BFS-ESW11 power supply L and N (Live and Neutral) terminals using suitably rated 2-core cable (refer Technical Specifications section for electrical details) ensuring correct polarity of connections. Verify secureness of cables.

i Strip AC mains wire length 4-5mm. Terminal tightening torque 0.5Nm (4.5lb-in).

n Power Supply can be unclipped from the DIN-Rail for easier wiring.

Connect suitably rated 2x1mm² cable, one wire to the black wired DIN terminal Negative (-) terminal and with other wire to the red wired DIN terminal; this will be 24VDC Positive (+) wire. Terminate the remote end with a Communication SuperSeal 2-pole socket (female) ensuring correct polarity of connections [Communication connector: pin 1 Positive (+24VDC), pin 2 Negative (0VDC)].

i Strip 24V DC wire length 10mm. DIN terminal tightening torque 0.5Nm (4.5lb-in).

n Do not remove wire links connected within the BFS-ESW11. Verify screw tightness in case of loosening in transit.

Connect the Communication SuperSeal 2-pole socket (female) to the BFS plug (male).

! Warning – When the PV array is exposed to light, it supplies a DC voltage to this equipment. Connect and disconnect DC input and DC output circuits individually. Do not turn ON mains voltage until installation of BFS-ESW11 is completed and verified.

! When wiring the BFS-ESW11, the waterproof plug must be installed.

BFS-11 INSTALLATION DIAGRAM DETAILS

One BFS-11 will control two solar panels and by series connection of the BFS, multiple solar panel pairs can be connected to form a greater capacity system. The diagram below illustrates a typical example of a BFS protected installation using six solar panels and three BFS-11

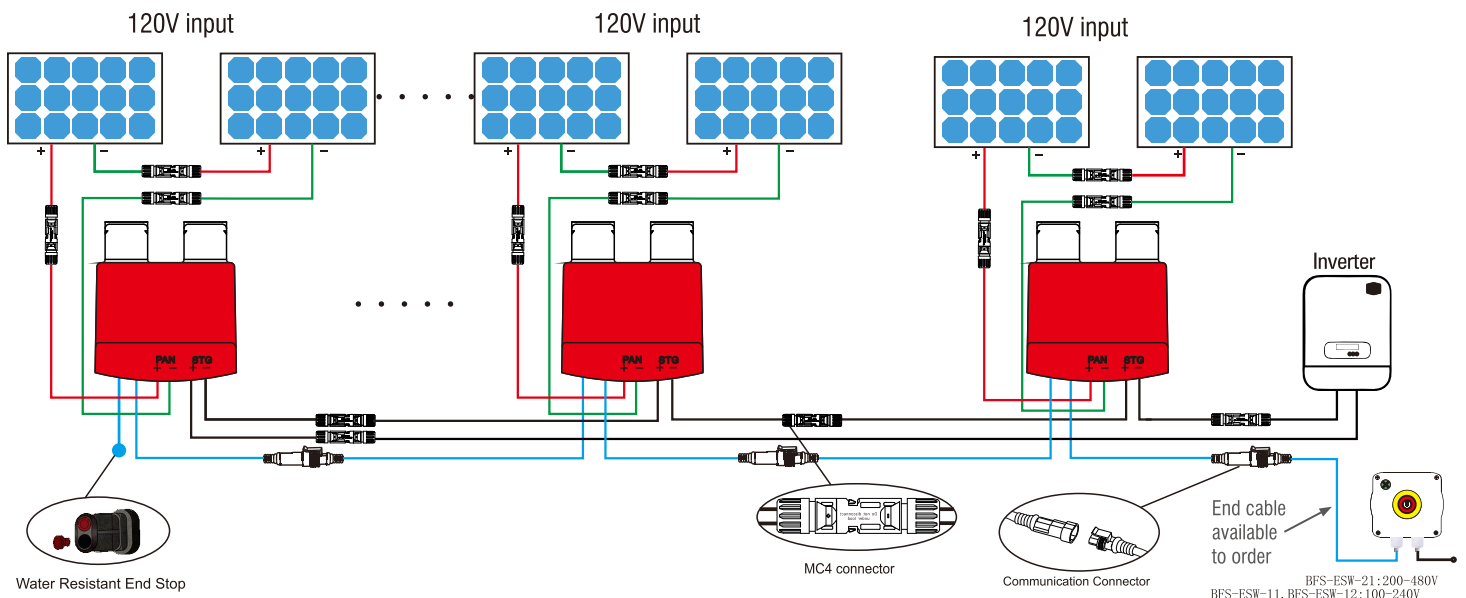

If the array has an odd number of panels, a single panel can be connected directly to the positive (+) and negative (-) panel cables of the BFS.

BFS-11 MULTI-STRING INSTALLATION DIAGRAM(Even number per string)

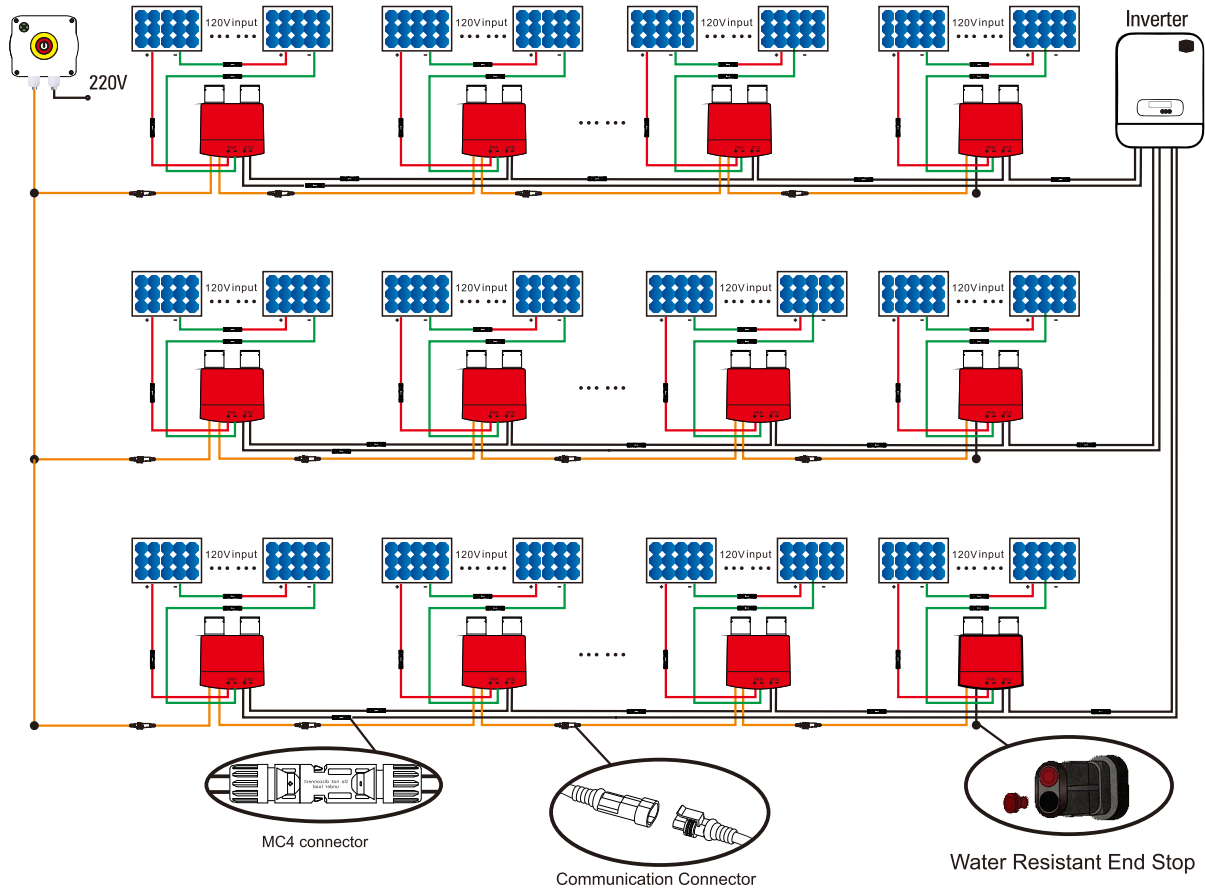

BFS-11 MULTI-STRING INSTALLATION DIAGRAM(Odd number per string)

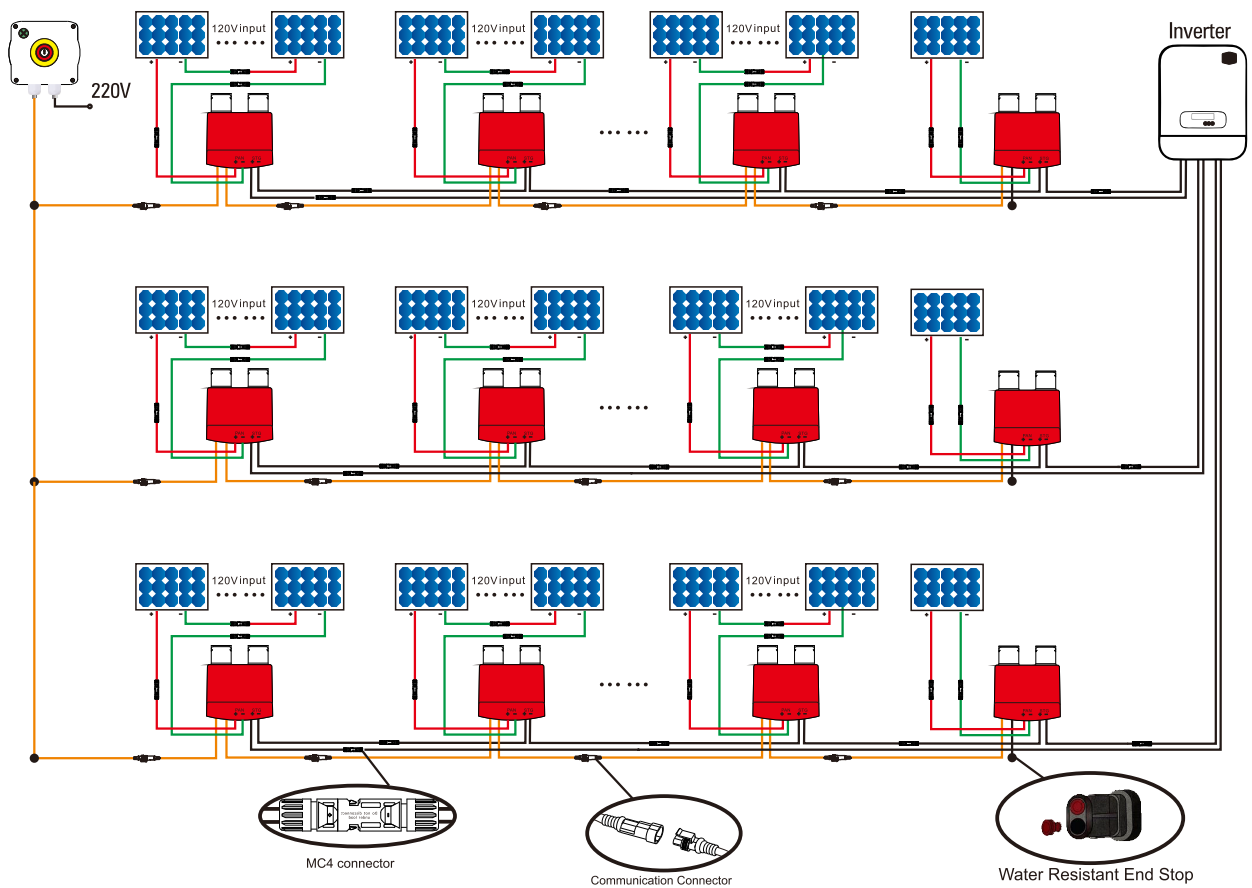

BFS-11 1-to-1 CONFIGURATION INSTALLATION DIAGRAM (to meet NEC 2017/2020 compliance)

For NEC 2017/2020 compliance, if the PV panel >40V, 1-to-1 configuration should be required in order to meet regulatory compliance. The diagram below illustrates a typical 1-to-1 configured BFS protected installation using three solar panels and three BFS-11.

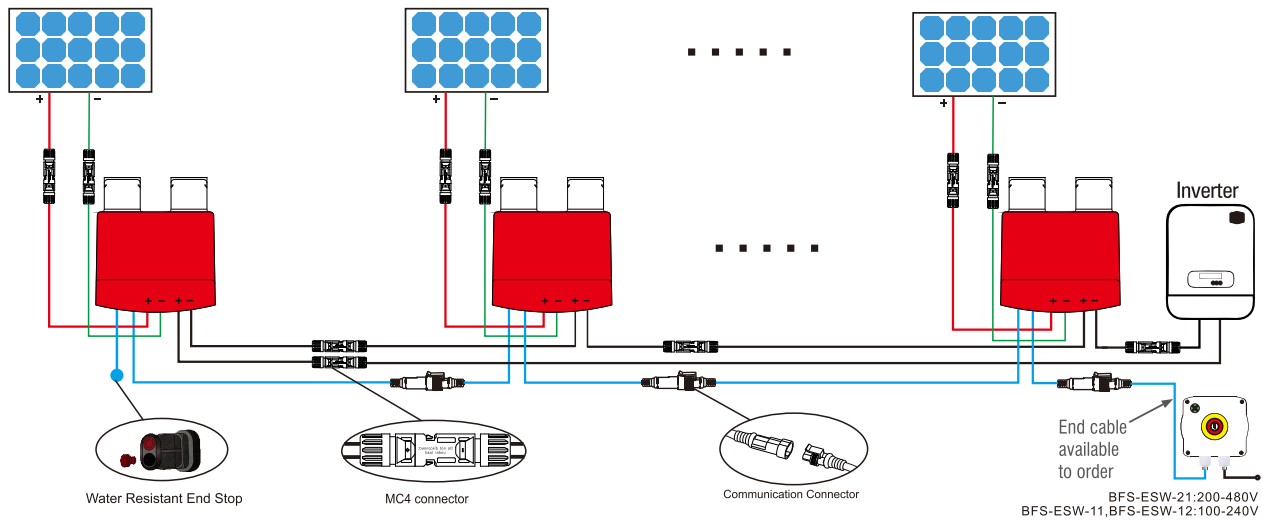

* Water resistant end stop - Insert the two red sealing plugs in to the Communication Superseal plug (supplied) and connect to the DC output connector of the last BFS-11 in the series in stallation. If only a single BFS-11 is used then this part is still used to seal the DC output connector.

** A 1.8m flying lead terminated at one end with a female communication connector is available to order under part number BFS-CCABLE.

OPERATION

Upon correct mounting and connection of the BFS to the solar panels and the Emergency Shutdown Switch; and the turning ON of the mains supply, the BFS will be operational.

1. Manual Shutdown

Upon the user operating the red push button switch located in the Emergency Switch Enclosure the BFS performs a Rapid Shutdown, disabling the PV array output.

2. AC Supply Cut-Off Shutdown

Should there be a necessity by the emergency services for local or area utility grid shutdown, disconnection of the external AC supply, by whatever means, will cause the ZJBENY BFS to perform a Rapid Shutdown disabling the PV array output.

3. Automatic Emergency Shutdown

Should the BFS-11 onboard temperature sensor detect a temperature in excess of 85°C then the BFS will instigate an Automatic Rapid Shutdown thereby disabling the PV module's output. Should the detected temperature then drop back to below 65°C ~70 °C, the BFS will re-engage the PV module's output.



The Emergency Shutdown Switch is a typical "one push" large red emergency push button which requires an anti-clockwise twist to release.



The BFS-ESW11 and BFS-ESW11-K includes an LED indicator which when used with BFS-11 signifies 24VDC power (ON) or power loss (OFF).

TECHNICAL SPECIFICATION

	BFS-11		BFS-11B	
Control Voltage Range (DC Power Supply)	14V~28V		14V~28V	
Maximum Control Current	8mA		15mA	
Maximum Control Power	0.15W		0.25W	
Control Cable Type (Signal Cable Type)	2x0.823mm ² (18AWG) Signal Cables + Signal Connectors		2x0.823mm ² (18AWG) Signal Cables + Signal Connectors	
Control Cable Length (Signal Cable Length)	1800mm		1800mm	
Maximum System Input Voltage	120V Single Panel Or 60V Per Panel (Two Panels In Series)		120V Single Panel Or 60V Per Panel (Two Panels In Series)	
Maximum System Input Current	18A	20A	18A	20A
Maximum System Input Power	2160W Single Panel Or 1080W Per Panel (Two Panels In Series)	2400W Single Panel Or 1200W Per Panel (Two Panels In Series)	2160W Single Panel Or 1080W Per Panel (Two Panels In Series)	2400W Single Panel Or 1200W Per Panel (Two Panels In Series)
Cable Lengths Type	4.0mm ² (12AWG) Cables + MC4 Connectors		4.0mm ² (12AWG) Cables + MC4 Connectors	
Panel Cable Lengths	180mm		180mm	
String Cable Lengths	1800mm		1800mm	
Operating Temperature	-40°C to +55°C		-40°C to +55°C	
Storage Temperature	-40°C to +85°C		-40°C to +85°C	
IP Class Protection	IP68		IP68	
PV Casing	Flame retardant PC - UL94-V0		Flame retardant PC - UL94-V0	
Standard Compliance	EN 62109-1:2010, EN 61058-1:2018		EN 62109-1:2010, EN 61058-1:2018	
PV Connectors	Staubli MC4 (Standard)		Staubli MC4 (Standard)	
	Jinko and QC connectors for option		Jinko and QC connectors for option	
Communication Mode	Not supported		POWERBUS	

* Please refer to the open circuit voltage (Voc) and the short circuit current (Isc) of the PV module.

Power Supply	BFS-ESW11(-K)	BFS-ESW12(-K)	BFS-ESW21(-K)
Input Voltage Rang	100-240VAC		200V-480VAC
Maximum Input Current	0.5A	0.88A	0.7A
Input Frequency Rang	47-63Hz		
Rated Output Voltage	24VDC		
Maximum Output Current	315mA	750mA	1250mA
Maximum Output Power	7.06W	18W	30W
Power Supply Connector Wiring	0.823mm ² / AWG 18		
Power Supply Torque	0.5 Nm / 4.5 lbin		
DIN Terminal Connector Wiring	0.5-4mm ² / AWG 26-10 (Note: BFS11/ BFS12 uses communication connector 2x0.823mm ²)		
DIN Terminal Torque	0.5 - 0.8 Nm / 4.5 - 7 lbin		
Ambient Operating Temperature	-30°C to +70°C		-30°C to +85°C
Maximum BFS Units	40 Units / 150M	90 Units / 150M	90 Units / 150M

* BFS-ESW11、BFS-ESW11/12-K Rapid Shutdown Switch can be upgraded to suit larger installations. Contact ZJBENY for more details.

TROUBLESHOOTING

Problem	Possible Cause	Possible Solution
Panel (pair) voltage is 0V	No mains supply (LED OFF)	Check area utility operational Check mains ON
	BFS-ESW11/12 power supply failure (LED OFF)	Check mains voltage between L & N marked terminals Check 24VDC between + & - marked terminals
	BFS-ESW11/12 switch activated	Turn red actuator anti-clockwise to release button
	No BFS-ESW11/12 switch output (LED OFF)	Check 24VDC between switch out terminal & PSU – marked terminal
	Broken cable (LED OFF)	Check 24VDC between terminals of remote communication SuperSeal connector (pin 1+24VDC\pin 2 0VDC)
	PV array not connected	Check all PV to BFS-11 input connections
	Incorrect BFS-11 polarity connection	Check PV array Positive (+) goes to BFS-11 Positive (+) and PV array Negative (-) goes to BFS-11 Negative (-)
	No BFS-11 output	Replace BFS-11
PV Inverter input 0V	No DC isolator (if fitted) input	Check BFS-11 output connections Check DC inputs to isolator
	DC Isolator (if fitted) OFF	Turn DC Isolator ON
String voltage too low	Incorrect BFS-11 polarity connection	Check all PV array Positive (+) go to BFS-11 Positive (+) and PV array Negative (-) go to BFS-11 Negative (-)

In the occurrence of a fire Zbeny recommend that all elements of the BFS Rapid Shutdown system be assessed for operational suitability by a competent person prior to re-energising.